

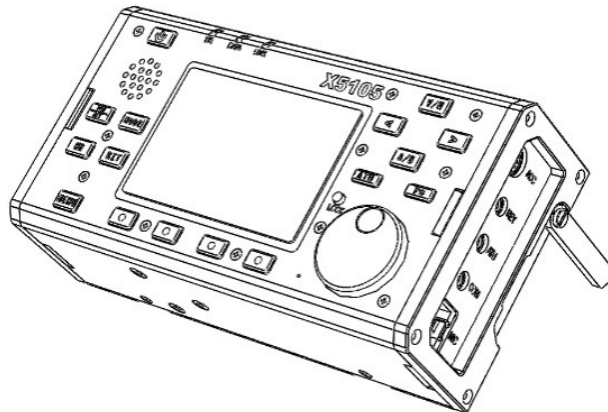

X5105

HF+50MHz Portable HF Transceiver

Quick-Start Manual



Important reminder:

Before attempting to operate your X5105, please read this operating manual carefully. Also, keep it handy for future reference.

Features:

- High-Visibility 3.6- Inch LCD Screen
- Built-in 3800-mAh high-capacity battery
- Built-in SWR Bridge and ATU
- All modes (USB/LSB/CW/AM/FM/Digital)
- All Bands (160-M through 6-M)
- General Coverage HF Receiver
- 1st-IF Signal Output for Spectrum Display
- DSP-NR, Noise Blanker, Notch Filter
- Memory Keyer with CW trainer
- Speech-Processing Compressor
- Variable-Width Passband Filtering
- Multi-function Keypad Microphone
- Built-in Desktop Stand
- Ultra-Compact, Self-Contained Portable

Security considerations:



Never operate this radio during a thunderstorm!



Avoid submersing this radio in water.



Never operate this radio in violation of FCC rules.



Avoid skin contact with antenna surfaces!

Packing list:

Qty

- ① X5105..... 1
- ② Power supply cable.....1
- ③ Hand microphone.....1
- ④ USB Cable.....1
- ⑤ Service card..... 1

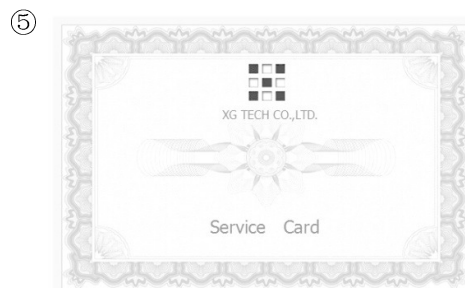
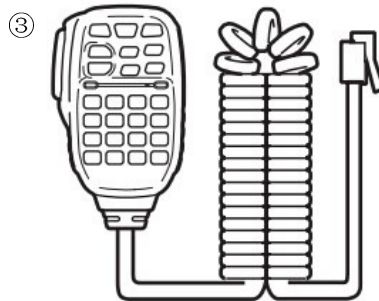
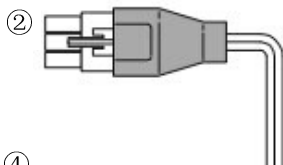
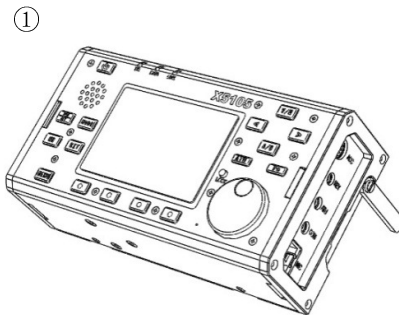

INTRODUCTION

Your new Xiegu X5105 is an ultra-portable multi-mode HF transceiver that delivers an unusually wide range of operating features – many normally only found on much larger base-station radios. For example, it comes with a 3.6-inch high-visibility LCD screen that displays a wide range of information covering virtually every aspect of the radio's operation. And, even though the X5105 is physically small, its operating controls have been thoughtfully laid out with adult-sized fingers in mind!

The transmitter covers 160 through 6 Meters with power output adjustable from 0.5 to 5.0 Watts. Transmit and receive modes include USB/LSB, CW, FM, AM plus digital inputs (1.5-W carrier on AM). You also get a built-in SWR Bridge plus a highly effective Automatic Antenna Tuner (ATU) that allow you to operate almost anywhere using a wide range of portable and fixed antenna systems.

The X5105 receiver is general coverage, tuning from the AM broadcast band through 30 MHz (plus 50-54 MHz). VFO tuning is velvet-smooth with 1-Hz resolution, and DX splits are easy using the VFO A/B mode and receive incremental tuning (RIT). You'll also notice that weak-signal reception and adjacent channel interference are well managed using a built-in Pre-Amp/Attenuator, pulse-type Noise Blanker, adjustable DNR (Digital Noise Reduction), Notch Filter, variable AGC-Rate, and adjustable-width Passband Filters. For serious CW operators, there's a multi-mode Auto-Keyer complete with memory channels and CW-trainer. For voice modes, you get a built-in Speech Compression processor to add punch when working DX – plus a sophisticated multi-function key-pad microphone that places many of the radio's most advanced operating features right at your fingertips.

Also, you can say goodbye to tangled patch cables and the extra “boxes” that normally accompany QRP operation because all the accessories you'll ever need are built right into the radio. There's even a front-panel microphone and MOX switch for operating in “speaker-phone” mode. Best of all, with its powerful 3800-mAh on-board battery pack, you get up to 6-8 hours of energy-independent portable operation between charges (the X5105 also operates from any regulated 9-15 Volt 3-Amp dc supply).

Even though it's loaded with features, the X5105 is still extremely compact and light, measuring 6-5/8” wide x 3-5/8” high x 1-7/8” deep, and weighing just 2.1 pounds. Positive proof that remarkable things come in small packages!

SPECIFICATIONS

Receive Range: 500kHz to 30MHz, 50MHz to 54MHz

Transmit Range: 160-M through 6-M (Amateur bands only)

Operating Mode: A1A(CW) , A3E(AM) , J3E(USB/LSB) , F3E(FM)

Temperature Range: -10°C ~ +60°C

Stability: First Hour, + 4ppm @25°C. After First Hour, 1ppm

Voltage: 13.8VDC ± 15%, (9–15 Vdc)

Current: Rx, 500 mA Peak, Tx, 2.5 A Peak

Battery: 3800 mAh @ 12Vdc

Dimensions: 6-5/8" W, 3-5/8" H, 1-7/8" D

Weight: 2.1 lbs.

Transmit Power Output : 0.5 – 5.0 W PEP SSB/CW/FM (0.5-W increments)

AM: Low-level Amplitude, 1.5-W Carrier

FM: Reactance Modulation, ±5kHz

Harmonics, Spurs: > -45dBc

AF Input: 200-10k (600-Ω microphone)

Receiver: Superhet, 1st IF: 70.455MHz, 2nd IF: 10.695MHz, 3rd IF: 455kHz (NFM only)

Sensitivity:

	SSB/CW	AM	FM
1MHz-1.8MHz	0.35uV	10uV	/
1.8MHz-28MHz	0.25uV	2uV	/
28MHz-30MHz	0.25uV	2uV	0.35uV
50MHz-54MHz	0.25uV	2uV	0.35uV

(PRE=on, ATT=off, NB=off, NR=off, SSB/CW/AM = 10dB S/N, FM = 12dB SINAD)

Image Rejection: -70dB

IF Rejection: 60dB

Selectivity: SSB : -6dB @ 2.4 kHz, -60dB @ 4.6 kHz

CW : -6dB @ 500 Hz, -60dB @ 2 kHz



AM : -6dB @ 6 kHz, -60dB @ 25 kHz

FM : -6dB @ 12 kHz, -60dB @ 25 kHz

DSP Noise Reduction: AF DSP, variable

AF Output: 0.6W into 8Ω , ≤10% THD

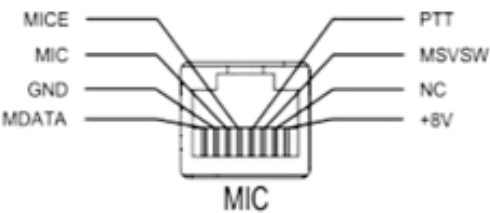
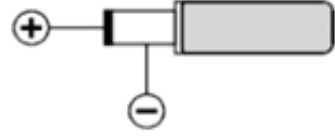
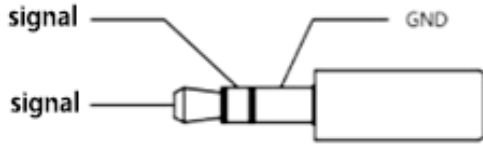
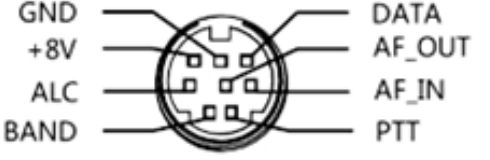
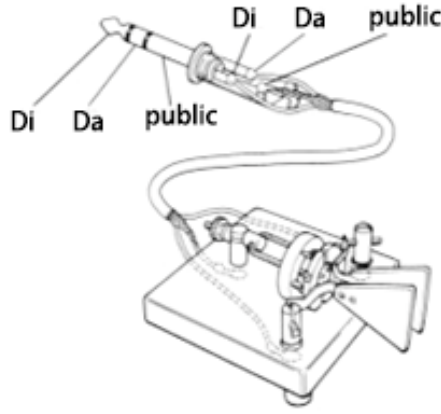
EXTERNAL CONNECTIONS

Microphone interface	DC power input 13.8V
 <p>Diagram of a microphone interface connector with the following labels: MICE, MIC, GND, MDATA, PTT, MSVSW, NC, +8V. The connector is labeled MIC.</p>	 <p>Diagram of a DC power input connector showing a positive (+) terminal and a negative (-) terminal.</p>
ACC	External connection speaker / earphone
	 <p>Diagram of an external connection for a speaker or earphone, showing two signal lines and a GND connection.</p>
ATU	Key
 <p>Diagram of an ACC connector with the following labels: GND, +8V, ALC, BAND, DATA, AF_OUT, AF_IN, PTT.</p>	 <p>Diagram of a key connection showing a cable with labels Di, Da, and public, connected to a mechanical key device.</p>
COM	
 <p>Diagram of a COM connector showing RXD and TXD lines and a GND connection.</p>	

INTERNAL BATTERY

The X5105 comes with a built-in 3800-mAh battery pack. When no external power source is connected to the radio, the battery supplies power by default. When an external source is connected, power-management circuitry switches to it automatically.

Charging Procedure:

1. In the menu, select the **[CHG]** option, then select **CHG ON**.
2. Adjust the external power source to between **13.5V-14.0V** and connect it to the X5105 power supply input. Charging will start automatically. You must apply at least 13.5 volts to ensure proper charger operation.
3. The maximum charge time for a fully depleted battery is about 10 hours. When the battery is fully charged, power-management circuitry terminates the charging cycle.

When the radio's battery power is nearly depleted, the battery symbol located at the upper right corner of the display screen will appear "empty":  At this point, you should switch to an external supply or recharge the battery. Note that during the recharge cycle, it is normal for the X5105 case to become warm.

Normally, the life span for the internal battery is around 3 years. When there is a significant drop in capacity or a charging failure, you may contact your dealer to obtain a replacement. Replacement costs beyond the warranty period are not covered.

IMPORTANT OPERATING WARNING: When your X5105 is connected to an external power source and the radio is in transmit mode, DO NOT disconnect the power supply. Doing so can damage the radio's power management IC chip.

IMPORTANT BATTERY WARNING: In the unlikely event the case of the X5015 becomes extremely hot around the battery area, turn off power immediately and remove the radio to a safe well-ventilated area! After confirming the safety of the situation, please contact us for proper handling information.

CONTROLS AND FUNCTIONS

Front panel:

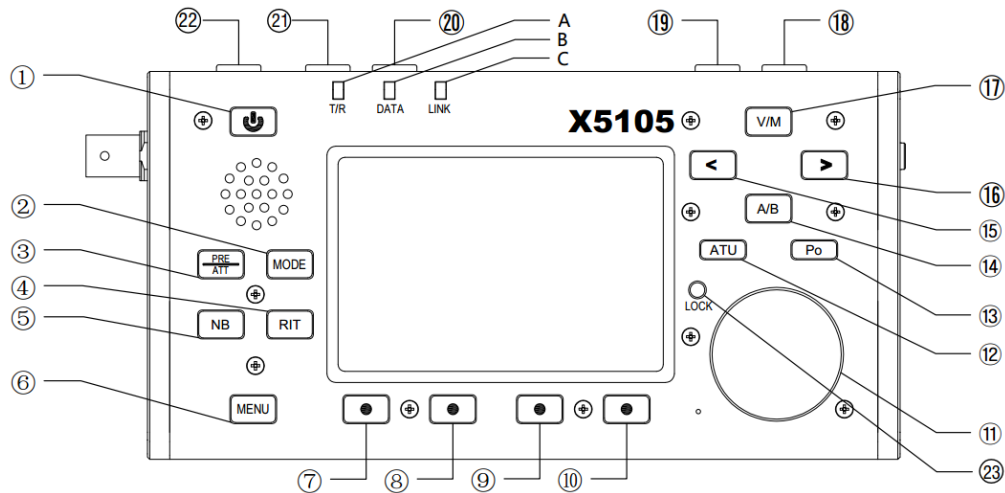

① Power Button:

Press and hold for 1 second to turn the radio **on** or **off**.

② Mode Button:

Step or scroll to change the radio's operating mode: **[LSB-USB-CW-CWR-NFM-AM]**

③ PRE/ATT Button:

Step or scroll to select sensitivity: **[PRE=ON, ATT=ON, PRE/ATT=OFF]**

④ RIT Button:

Press to toggle the **RIT** (receiver incremental tuning) function **on** or **off**.

⑤ NB Button:

Press to toggle the **NB** (noise blanker) function **on** or **off**.

⑥ MENU Button:

Press to switch the display to the Multifunction **Menu**.

⑦ - ⑩ Multifunction-Menu Buttons:

Press to access desired function (displayed above each button on the menu screen).

⑪ Main Tuning Knob:

Tunes the X5105 **VFO**, or adjusts **menu parameters**.

⑫ ATU Button:

Press momentarily to connect the ATU (automatic antenna tuner) to the antenna port.
Press and hold to activate the ATU's automatic tuning cycle.

13 Po Button:

Press and rotate the **VFO knob** to set **power output** level (0.5W-5W).

14 A/B Button:

Toggles between **VFO-A** and **VFO-B**.

15 < Button:

Press to shift VFO frequency step one decimal point to the left.

16 > Button:

Press to shift VFO frequency step one decimal point to the right.

17 V/M Button:

Press to toggle between **VFO** mode and **MEMORY** mode.

18 Up Button:

Step or toggle to select a **higher-frequency band**.

19 DN Button:

Step or toggle to select a **lower-frequency band**.

20 (-) Button:

Step or toggle to **lower-volume** setting.

21 (+) Button:

Step or toggle to select a **higher-volume** setting.

22 PTT Button:

Press and hold to enter **transmit mode** (MOX function).

23 LOCK Button:

Press to lock all control settings. Press and hold to release control lock.

Press and hold for several seconds to toggle the display backlight **on** or **off**.

Colored Status LEDs: (located above display screen)

A - T/R: Green LED = Receive Mode, RED LED = Transmit Mode

B – DATA: When a data signal is present or the channel is busy, LED flashes.

C – LINK: When the radio is connected to peripheral equipment, LED is on.

Menus Corresponding to Multi-Function Buttons (below the screen)

Menu-1

A=B	SPL	NR	NTH
Copy VFO-A to the background	Turn Split On/Off	Set Digital Noise Reduction	Adjust Notch

Set Menu-2

AGC	FIL	SRM	SWR
Set AGC Time Constant	Select IF-Filter Passband	Scan Receive Mode	SWR Scan

Menu-3

M > V	MW	MC	TAG
Move memory entry to VFO	Store current channel to memory	Clear Current Channel	Use to “tag” current channel with custom ID. Press and hold to activate edit feature.

Menu-4

BK	KEY	KSP	-
CW insert function on / off	Select manual or auto-keyer function	Set Keyer Speed	-

Menu-5

RE1	RE2	RE3	CSN
Set CW Message-1 Press and hold to enter edit function.	Set CW message-2 Press and hold to enter edit function.	Set CW message-3 Press and hold to enter edit function.	Set up power-on CW call sign – Press and hold to edit

Menu-6

SQL	CMP	MTR	VLT
Squelch function	Speech compression	Display switch of multi-function table	Power / voltage display switching

Menu-7

CHG	MSL	IFO	VER
Charging switch	Built-in / external MIC selection	IF output switch	Firmware version display

SCREEN DISPLAY

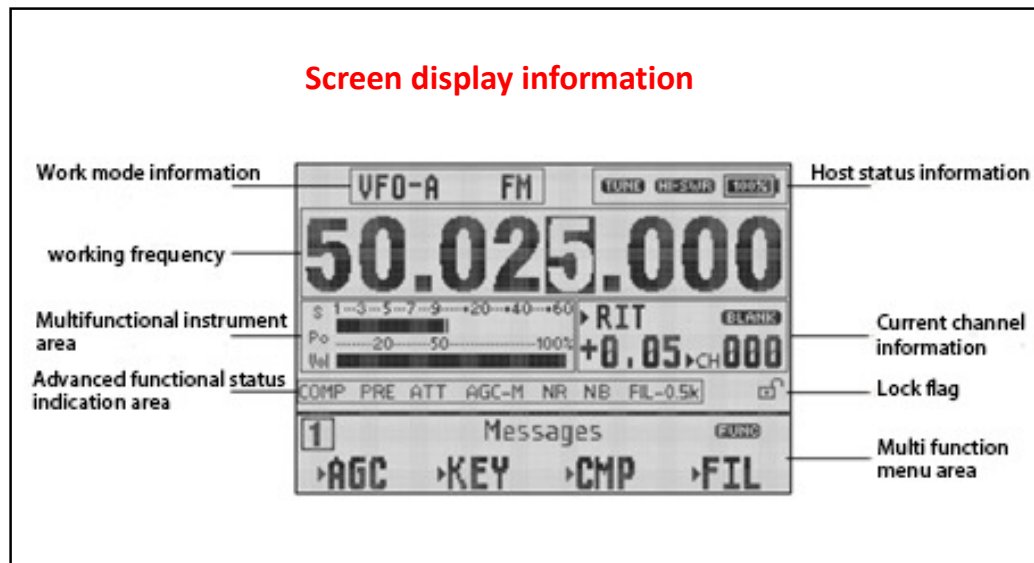

LEFT-SIDE PANEL CONNECTIONS:

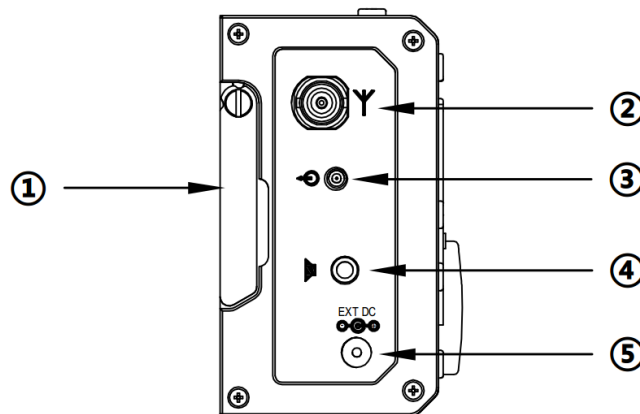

① Desk Stand Bracket:

Swings down to prop radio up on a table or desktop.

② Antenna Connector:

Accepts 50 Ω BNC-Male connector from antenna system

③ IF-Signal Output:

Connects the 1st-IF output signal to Xiegu XDT1 data terminal or spectrum display.

④ External Speaker or Headphones:

Accepts 3.5mm stereo plug (3 wire) for external speaker or phones (4-16 Ω).

Important Warning: Always reduce volume setting before plugging in headphones or ear buds. High volume setting could damage your headphones or impair your hearing!

⑤ DC Power Connector:

Accepts a standard 2.1 mm x 5.5 mm coaxial power plug, (+) center. Supply must deliver 13.8-V @ 3-A to operate radio and fully charge battery.

RIGHT-SIDE PANEL CONNECTIONS:

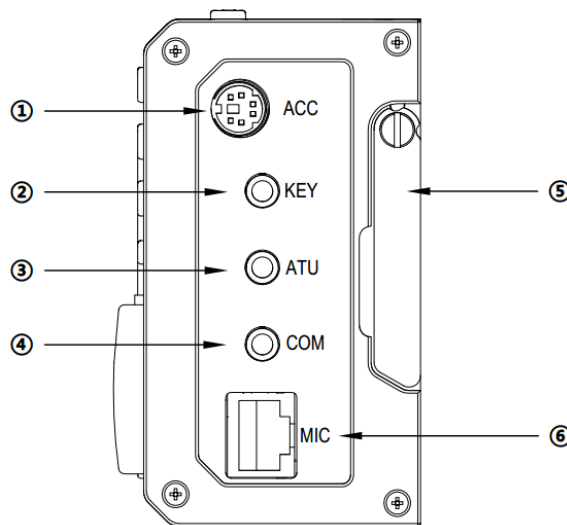

① ACC (Accessory) Jack: Accepts male 8-PIN micro-DIN connector. May interface with external power amplifier, data controller, or computer for a variety of functions.

② KEY Jack:

Accepts 3.5mm stereo plug for use with manual or automatic keys.

③ ATU Jack:

Accepts 3.5-mm stereo plug, may be used to control external power amplifier.

④ CIV Interface:

Accepts 3.5mm stereo plug – may be used to connect with computer-aided control system or interface with computer for firmware updates.

⑤ Right bracket:

Swings down to prop up radio on table or desk top.

⑥ MIC (microphone) Jack:

Jack accepts microphone connector.

HANDHELD MICROPHONE:

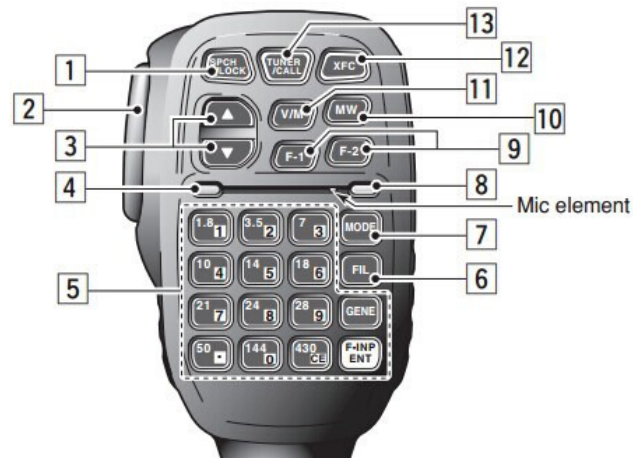

1. **Lock Button:** Toggle to lock or unlock radio's controls
2. **PTT Button:** Push to Transmit
3. **Up/Down:** Tune VFO frequency higher or lower.
4. **Rx/Tx LED:** Displays Receive/Transmit status.
5. **Digital keypad:** 1-10 Tone Encoder.
6. **FIL Button:** Toggle to change filter passband.
7. **MODE Button:** Toggle to change operating mode.
8. **LED:** Not used.
9. **F1/F2:** Custom settings buttons.
10. **MW:** Memory Write button (store frequency).
11. **V/M:** Switch between VFO and stored frequency.
12. **XFC Button:** No function
13. **CALL Button:** Press and hold for Automatic Antenna Tuning (ATU)